

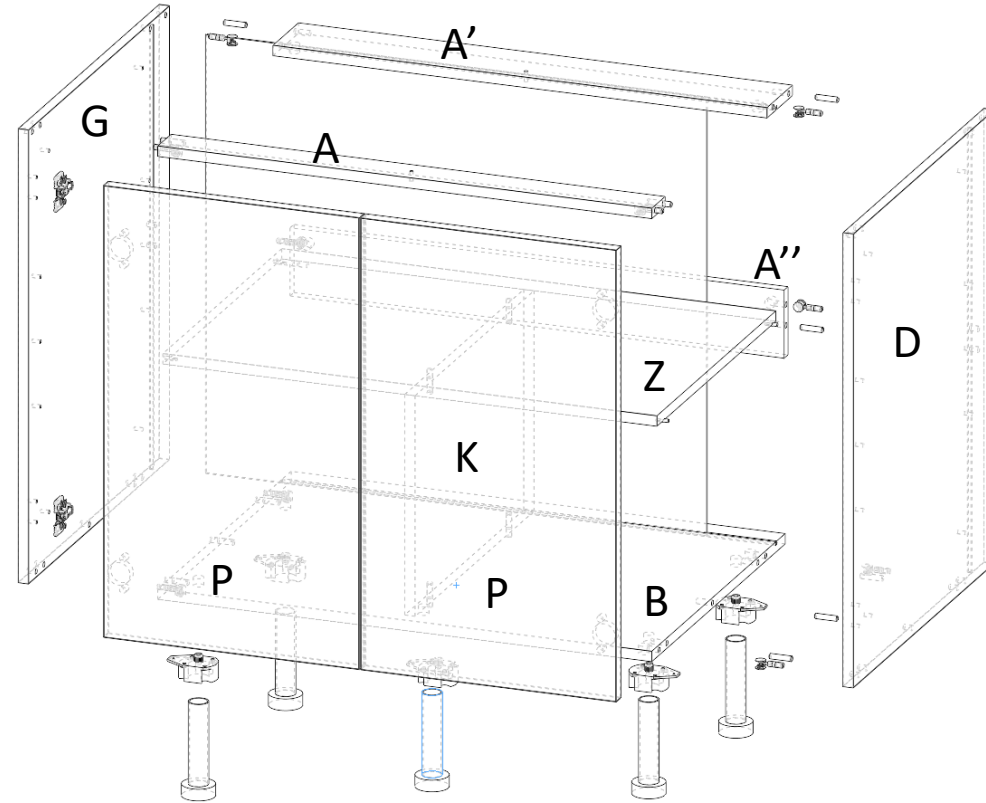

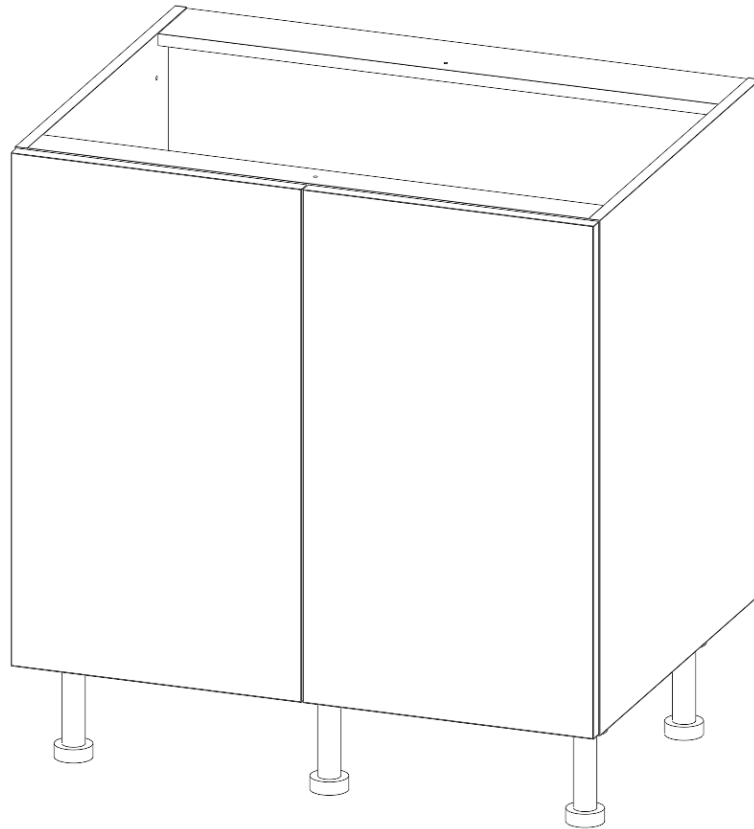









Meuble Bas 2 Portes

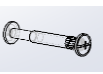

No. Article	Désignation	Qté
A-A'-A''	Traverse	3
B	Bas	1
C	Charnière	4
D	Coté Droit	1
E	Embase Charnière	4
F	Fond	1
G	Coté Gauche	1
I	Embase pied	5
J	Pied	5
K	Renfort / Séparation	1
L	Equerre plastique	2
P	Porte	2
Q	Goujon	8
R	Tourillon	12
S	Excentrique	8
V	Butée de porte	4
W	Cache bras	4
X	Cache boîtier	4
Y	Taquet étagère mobile	10
Z	Etagère mobile	1

Etapes de Montage:

Image	Nom	Qté
	CHARNIERE	4
	EMBASE CHARNIERE	4
	EXCENTRIQUE	10
	CACHE BOITIER CHARNIERE	4
	CACHE BRAS CHARNIERE	4
	GOUJON	10
	TAQUET	4
	TOURILLON BOIS	16
	VIS DE JONCTION	4
	EMBASE PIED	5
	PIED	5
	BUTEE	2

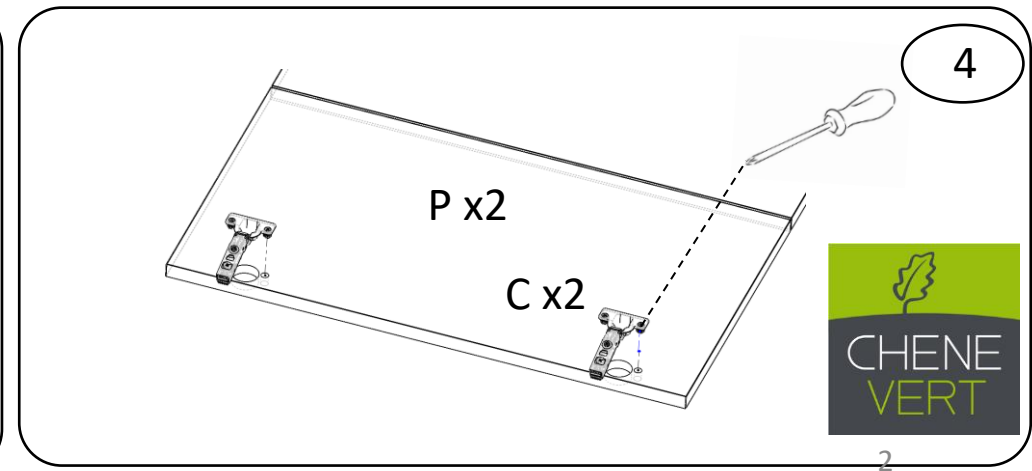
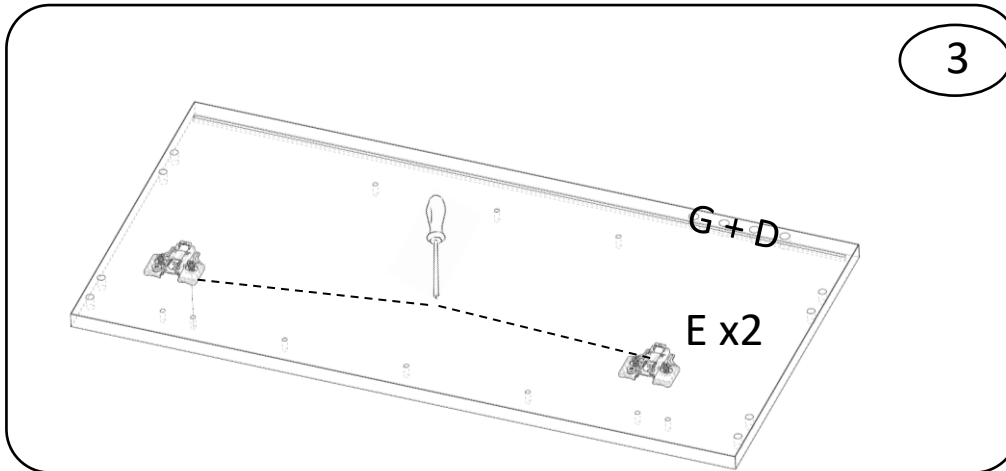
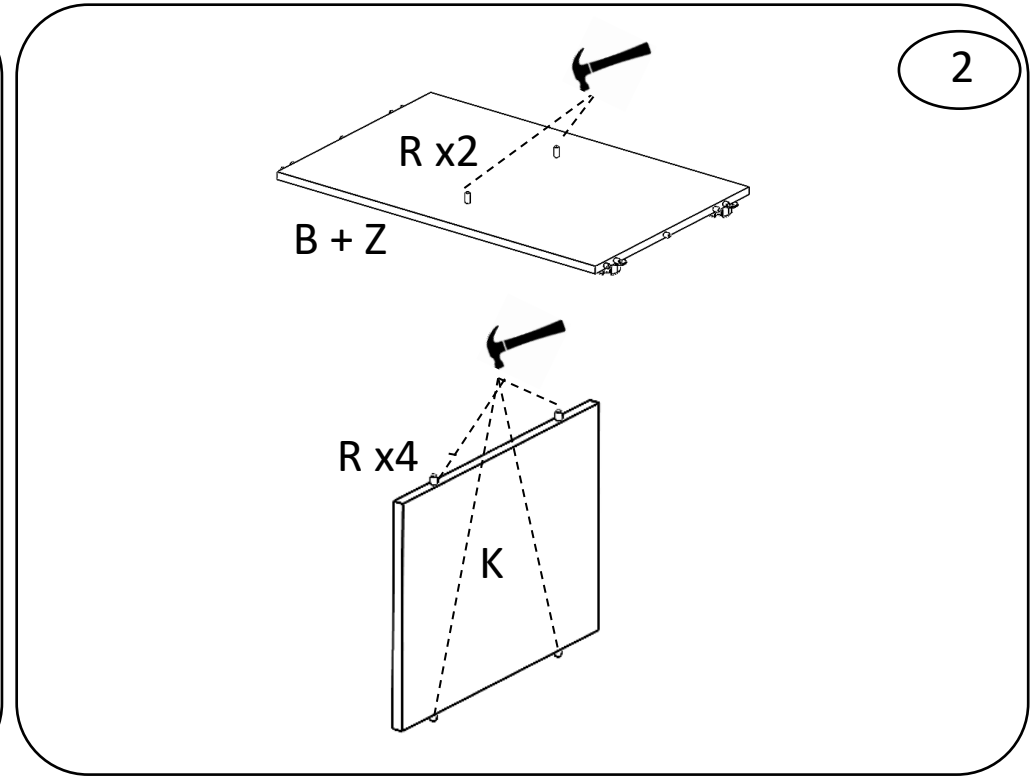
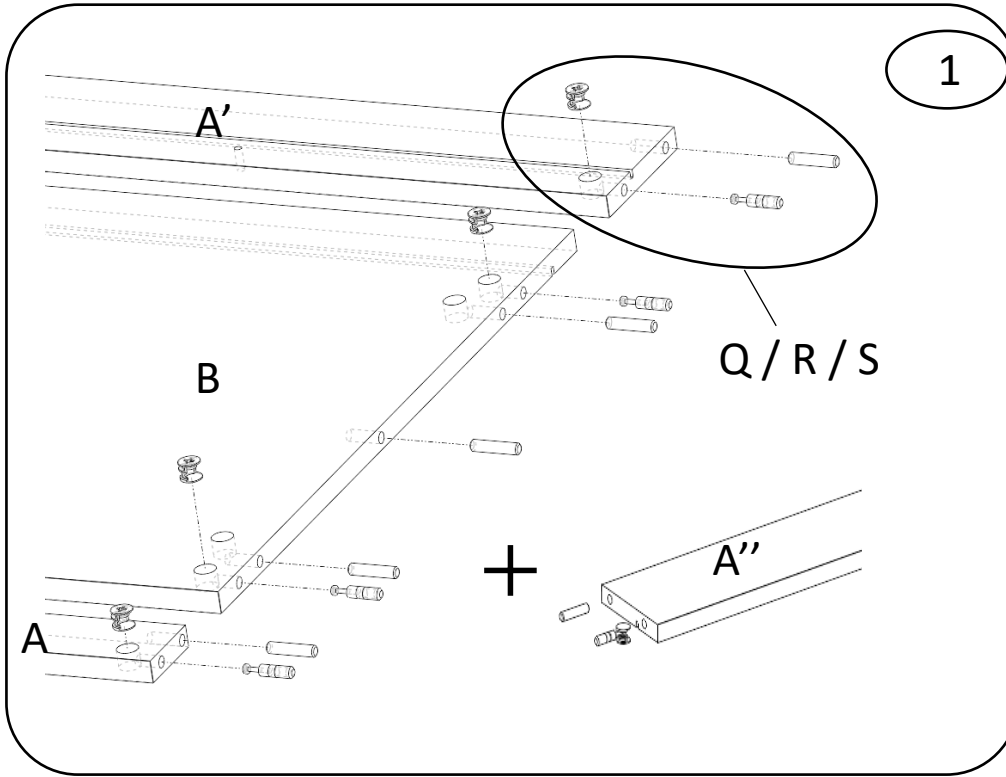

Etapes de Montage:

5

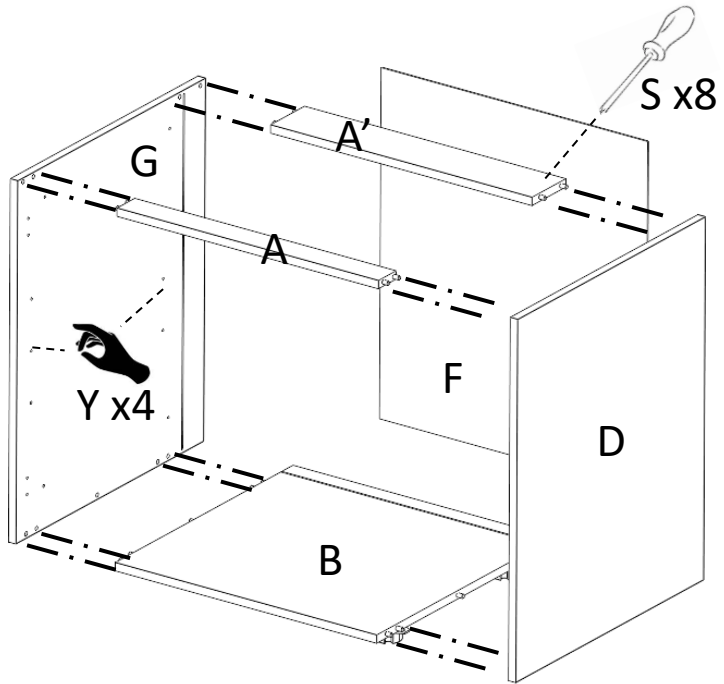

6

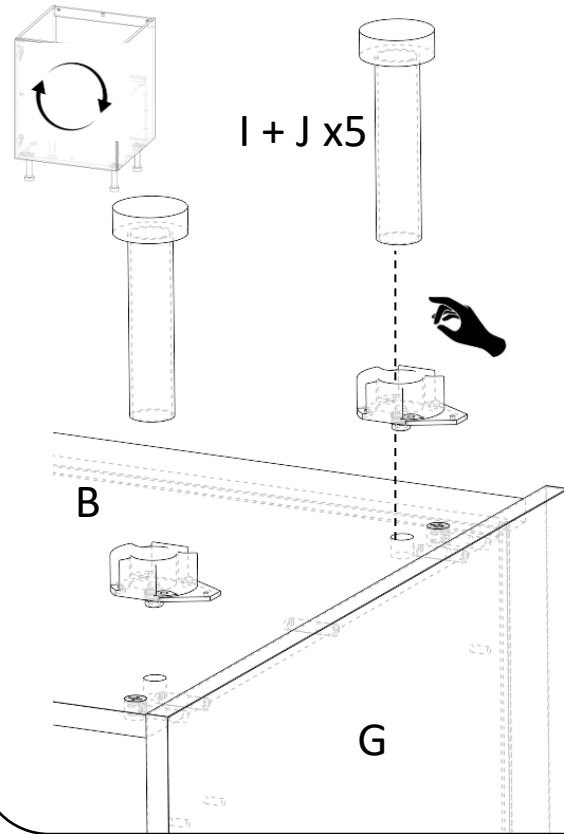

7

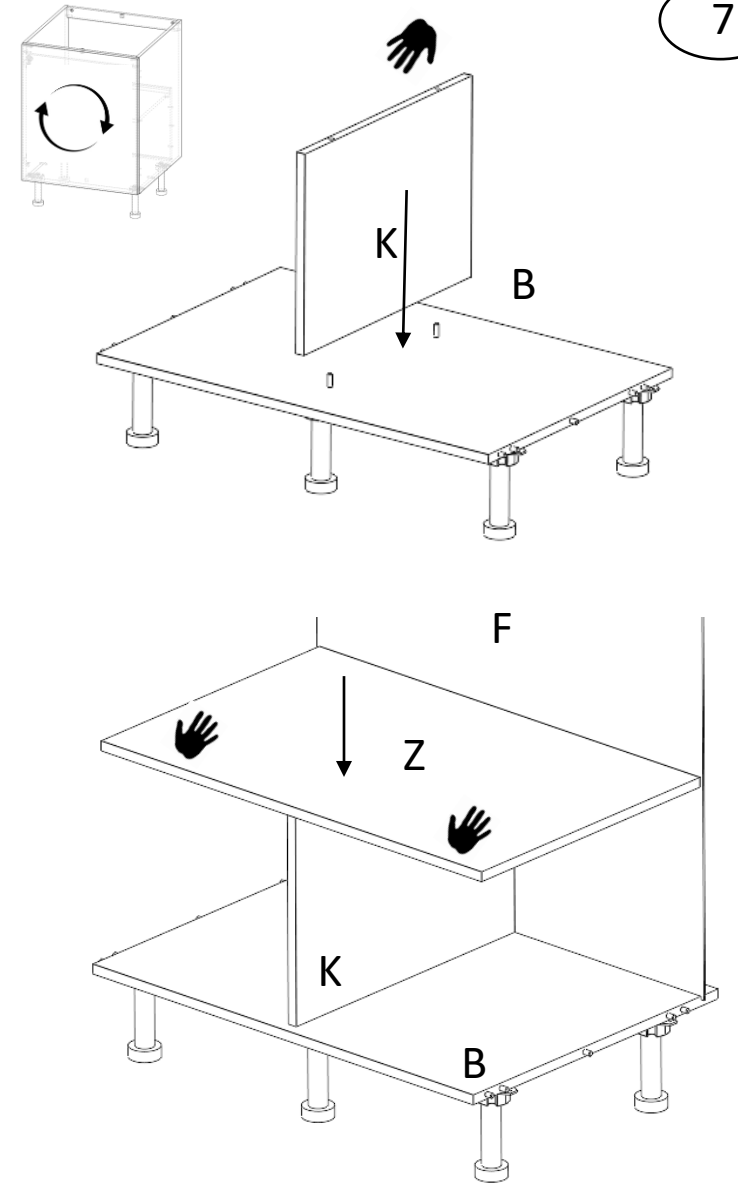

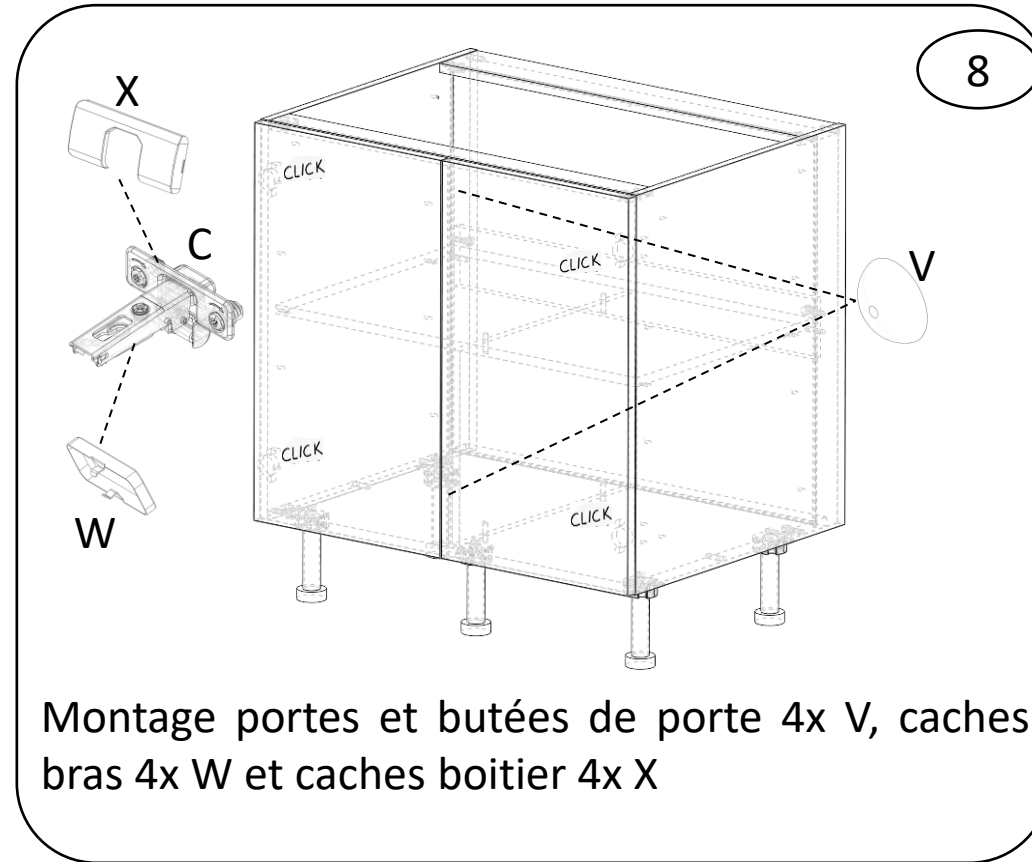

Montage portes et butées de porte 4x V, caches bras 4x W et caches boitier 4x X